

# Catalyst handling best practice guide

**European Catalyst Manufacturers Association**  
Avenue Edmond van Nieuwenhuyse 4, 1160 Brussels, Belgium  
Tel. +32 2 676 72 24, [bpi@cefic.be](mailto:bpi@cefic.be)

**A sector group of Cefic**   
European Chemical Industry Council - Cefic aisbl

EU Transparency Register n° 64879142323-90

ECMA1004q – 9 September 2018 – Page 1 of 37

## Catalysts Europe

The European Catalyst Manufacturers Association/Catalysts Europe is a sector group of the European Chemical Industry Council (Cefic) and represents the leading catalyst producers in Europe. Catalysts Europe is a non-profit organisation established in 1983 and dedicated to promoting the safe use and benefits of catalysts to society.

Catalyst plays a vital role in everyday life by making many products possible, improving process efficiency, reduced energy consumption and reduction of emissions and waste.

One of Catalyst Europe's major goals is to promote the safe use of catalysts over the whole life cycle including manufacture, installation and spent catalyst management including regeneration, recovery and disposal. Spent catalysts have been recycled for many years and have made a significant contribution to reducing waste and the circular economy. Dedicated catalyst regeneration companies are members of Catalysts Europe.

## Acknowledgements

This document was put together with the support of a number of catalyst handling companies including BUCHEN-ICS, Cat Tech, Mourik, Petroval, Technivac and Unicat. Catalyst handling is a specialised area and this support was invaluable.

## Disclaimer

***The information contained in this document is intended for guidance only and whilst the information is provided in utmost good faith and has been based on the best information currently available, it is to be relied upon at the user's own risk. No representations or warranties are made with regards to its completeness or accuracy and no liability will be accepted by Catalysts Europe or any of its members for damages of any nature whatsoever resulting from the use of this information.***

## CONTENTS

1.0	Introduction.....	5
2.0	What are catalysts? .....	6
2.1	Self-heating catalysts.....	7
3.0	Basic aspects.....	8
3.1	Reactor entry.....	8
3.2	Confined space operation .....	8
3.3	Working in inert atmosphere/nitrogen .....	8
3.4	Reactor conditions.....	8
3.5	Static electricity .....	8
3.6	Ancillary operations.....	8
3.7	Packaging.....	8
3.8	Health risks .....	8
4.0	Catalyst reactors .....	10
4.1	Fixed bed reactor.....	10
4.2	Tubular reactor/reformer.....	11
4.3	Fluidised bed reactor.....	11
5.0	Catalyst loading hierarchy .....	12
6.0	Reactor entry.....	13
7.0	Loading and unloading operations .....	15
7.1	Preparation for loading or pre-bagging.....	15
7.2	Loading into or unloading from the reactor .....	15
7.3	Screening .....	15
7.4	Spent catalyst management.....	15
7.5	Waste management .....	15
7.6	Ancillary operations.....	15
7.7	Preparation for loading .....	15
8.0	Loading operations .....	16
8.1	Vacuum loading .....	16
8.2	Automated systems.....	16
8.3	Loading directly from bigs bags or drums .....	17
8.4	Dense loading method .....	19
8.5	Sock loading method .....	20
8.6	Tube reactor/reformer loading.....	21
9.0	Catalyst unloading .....	23

9.1	Gravity unloading .....	23
9.2	Vacuum unloading.....	23
9.3	Wet unloading .....	25
9.4	Agglomerated catalyst.....	25
10.0	High exposure risks.....	27
11.0	Personal Protective Equipment (PPE) .....	28
Annex 1	- Best practices list.....	29

## 1.0 Introduction

The goal of this document is to provide guidance on the handling of catalysts in the safest possible way for human health and the environment. Catalysts are used in a wide range of applications and it is important that they are used in a safe way. Catalysts are made up of different chemicals with varying safe use requirements and this should be taken into consideration in their use.

**This best practice guideline is focused on solid heterogeneous catalysts installed in reactors.** For a better definition, please see section on catalyst types. Liquid catalysts, which are not covered in this document, can consist of hazardous substances and the reader is advised to follow the recommended risk management measures described in the corresponding safety data sheet (SDS). However, generally this best practice guideline is also applicable for the handling of raw powder catalyst materials.

This guide is intended for users, handling companies and designers of catalyst systems. It covers catalyst specific guidance and is designed to supplement general safety practices. Catalyst handling often involves Confined Space Entry and working in hazardous chemical and refinery sites. This guidance assumes compliance with all applicable local legislation, specific site regulation and safety schemes such as the VCA (Dutch Safety, Health and Environment Checklist for Contractors).

This guide has two sections. The first part is a description of different aspects including the various techniques used in catalyst loading and unloading. The second part in annex 1 is a listing or check of the items that should be considered during these operations.

## 2.0 What are catalysts?

A catalyst is a substance the rate of a chemical reaction, but is usually not consumed by the reaction. A catalyst is normally chemically unchanged at the end of the reaction. Many catalysts are complex mixtures of different chemicals.

There are two basic types of catalysis:

**Homogeneous** - The reactants and the catalyst are in the same phase, generally in solution. The catalyst is usually recovered from the final product stream by a process such as distillation. It is the reused until the catalytic activity is no longer sufficiently high. Often the raw catalyst material is supplied as a powder and the catalyst needs to be dissolved in an appropriate solvent before the catalyst can be utilised.

**Heterogeneous** - The reactants (normally liquid or gaseous) and the catalyst (normally solid) are in different phases. The pellets may be spherical, cylindrical, or randomly shaped. Many catalysts used in heterogeneous processes are extremely complex. Normally they consist of a number of principal components on an inert support material such as aluminium oxide or silica. When these solid catalysts are handled, they may generate airborne dust and therefore may present a risk when inhaled.



Figure 1: An example of catalyst pellets.

Catalysts gradually lose their catalytic activity, usually through structural changes, poisoning, overheating or the deposition of extraneous material such as coke. A catalyst is “spent” when it no longer exhibits the necessary activity or specificity required by the user. Depending primarily upon the chemical and structural changes in the catalyst during use, the user may have a number of options for dealing with the spent catalyst, which include:

- Regeneration and reuse of the material.
- Recovery of some or all of the components in the material
- Disposal of the material

## **2.1 Self-heating catalysts**

These are mixtures which in large quantities and after a prolonged duration (several hours or days) are liable to self-heat in contact with air and without an energy supply. This may include some fresh and spent catalysts. Loading and unloading normally take place under nitrogen to create an inert environment and appropriate packaging and labelling is required. Wet dumping using water can also be used. The self-heating property may be due to the catalyst being in a reduced state or because of and/or iron sulphide contamination of spent catalysts.

### **3.0 Basic aspects**

#### **3.1 Reactor entry**

This is required in some places as described in later sections. This is a critical operation requiring suitable breathing and skin protection. Those entering the reactor must have appropriate training and certification.

#### **3.2 Confined space operation**

Many catalyst operations involve entry into confined space. Confined space safety and permit procedures must be followed for these operations.

#### **3.3 Working in inert atmosphere/nitrogen**

Many catalyst loading and unloading operations have to be carried out in inert atmosphere, normally under nitrogen such as with self-heating catalysts. Typically, this is carried out by feeding nitrogen up flow through the reactor during either loading or unloading. Detailed procedures for working in inert atmosphere/nitrogen should be strictly followed.

#### **3.4 Reactor conditions**

The reactor should be purged of the process liquids and gases as much as possible before catalyst handling operations should start. The temperature should also be suitable for the operations. This is often 40°C but ideally it is below the body temperature of 37°C to prevent heat stress for the operators.

#### **3.5 Static electricity**

Vacuum systems and hoses have a risk to generate enough static electricity to ignite combustible atmospheres. Equipment and procedures such as conductive hoses should be used to prevent this.

#### **3.6 Ancillary operations**

Catalyst loading and unloading normally involves working at height and with forklifts and cranes. Suitable procedures and training should be in place to ensure safe operation.

#### **3.7 Packaging**

This includes big bags (FIBC), drums and forklift movable 1 – 2m<sup>3</sup> bins. The packaging should be UN approved packaging suitable for the catalyst or spent catalyst. Minimising the changeover of bags and drums can also reduce exposure.

#### **3.8 Health risks**

Many substances used in catalysts have hazardous properties that can be linked to adverse health effects. The main method to check the safety is in the safety datasheet (SDS) that is available from catalyst manufacturers



or suppliers. As well as information on the hazards, the SDS contains details for the handling, transport and risk management measures such as personal protective equipment (PPE).

As well as the fresh catalysts, spent catalysts may include hazardous substances. These include residual substances which are chemicals that remain on the catalyst from the processed streams such as hydrocarbons or incident substances that have been formed in the reaction process.

Hazardous substances may be present as dust, vapour and gas and can enter the body by a number of routes with the most likely routes via inhalation and skin absorption.

Some substances in catalysts can cause severe adverse health effects, if the catalyst is not handled properly. Generally, these hazardous substances can be grouped into the following categories:

**Residual substances** - Chemicals that remain on the catalyst from the processed stream. Depending on the installation, this can include substances such as benzene, butadiene or ethylene oxide.

**Incidental substances** - Probably the most concerning are metal carbonyls. Substances such as nickel carbonyl and vanadium carbonyl are some of the most toxic substances encountered in industrial processes.

## 4.0 Catalyst reactors

### 4.1 Fixed bed reactor

This is the most common type and is typically a cylindrical vessel filled with catalyst pellets with the gas or liquid reactants flowing down-flow through the bed and being converted into products. The reactor may have more than one catalyst in layers and inert ceramic balls to support the catalyst and improve flow and distribution of the process gas or liquid. Ceramic balls are normally used as they are strong, can withstand high temperature and pressure, do not absorb liquid or gases and are resistant to chemical attack including acid, alkali and organic solvents.

The reactor may have multiple configurations including one large bed or several beds in series. Reactors may have openings or internal transfer tubes to allow the catalyst to flow by gravity from the top of bed to the bottom bed during loading and unloading. Reactors in some cases have dump nozzles to allow catalyst emptying by gravity. Multiple bed reactors can have side manways to allow easy access into each bed or have internal catalyst support grids and trays with removable sections that can be removed to allow access to the next bed.

Ideally, catalyst handling is taken into account in the design of the reactor to ensure exposure to catalysts to be minimised during loading and unloading.

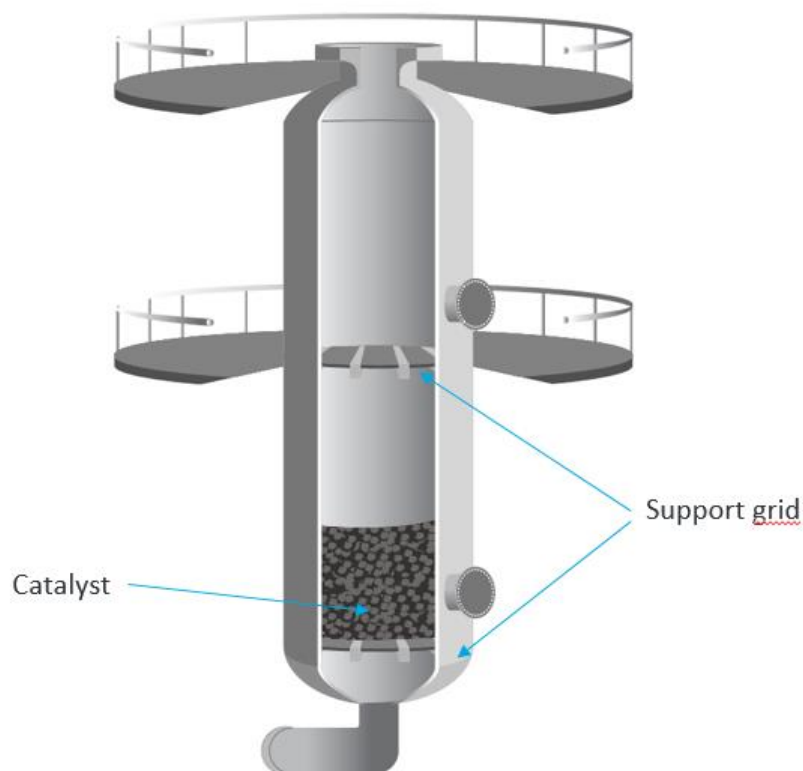

Figure 2: Example of a fixed two bed multiple catalyst reactor.

## 4.2 Tubular reactor/reformer

This consists of a series of tubes containing the catalyst. This is normally used where the process has to be carried out at high temperature where hot gases are on the outside of the tubes. Tubular reactors are also used where the process is highly exothermic and coolant is on the outside of the tube and where it is difficult to obtain and maintain the temperatures if a single bed was utilised. This type of reactor presents challenges for loading and unloading as the catalyst has to be put in and removed from these narrow diameter tubes without damaging the catalyst. Tubular reactors can have fixed or removable top and bottom domes or covers to access the tubes and install or remove the catalyst.

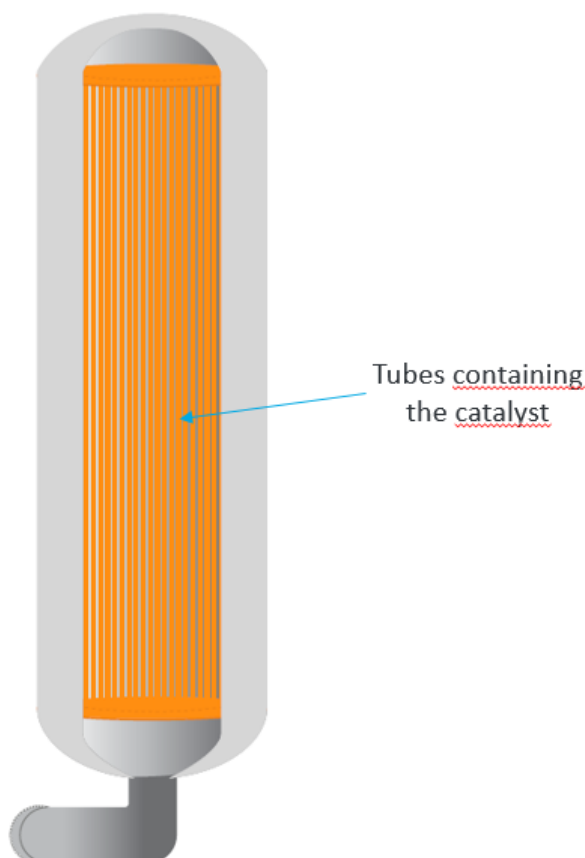

Figure 3: Example of tubular reactor.

## 4.3 Fluidised bed reactor

A fluidised bed reactor suspends small catalyst particles by the upward motion of the fluid to be reacted. The fluid is typically a gas with a flow rate high enough to mix the particles without carrying them out of the reactor. Fluidised bed reactors are typically multiple vessel units whereby under normal operation, the catalyst will migrate between vessels. This allows the catalyst to be moved through the vessel and into regeneration sections that will regenerate the catalyst and return it to the top of the reactor. A common fluid bed reactor is for Fluid Catalytic Cracking (FCC) used to crack heavy hydrocarbon feedstocks.

## 5.0 Catalyst loading hierarchy

This is included in Figure 4 and gives an overview of the preferred options in the handling of catalysts. The choice will depend on the particulars of the installation and the equipment available.

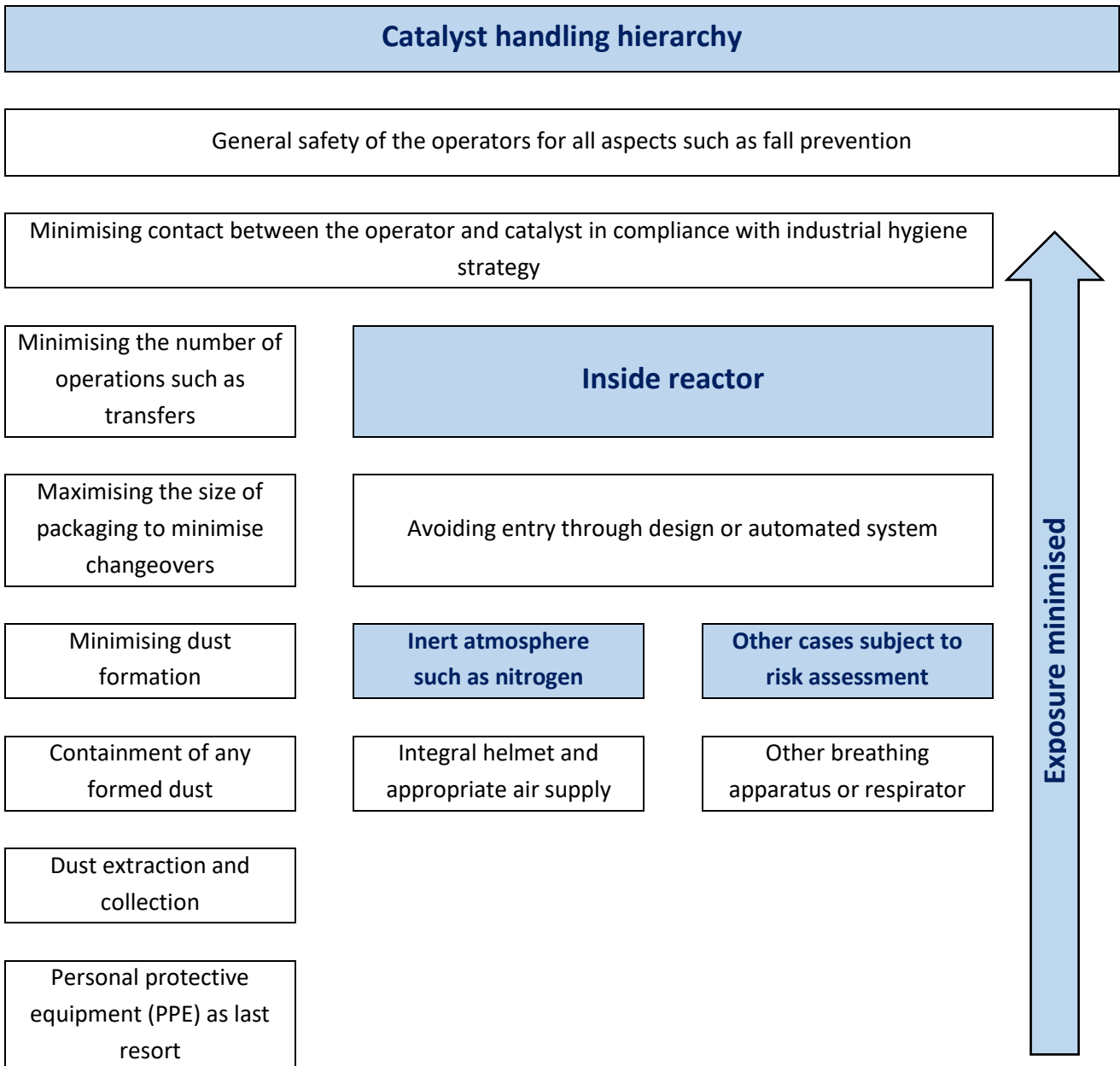

Figure 4: Catalyst handling hierarchy.

## 6.0 Reactor entry

As described in the catalyst loading hierarchy, avoidance of reactor entry is the preferred option. If reactor entry is required, particularly in the case of inert/nitrogen atmosphere or other potentially hazardous residual or incidental substances, an appropriate breathing apparatus such as an integral helmet and appropriate air supply is normally required. In some cases, other breathing apparatus or respirator is sufficient as long as a full risk assessment for reactor entry and confined space operation has been undertaken.

Reactor entry is a high risk operation and strict procedures are required including CE approved specialised equipment, supervision and training required.

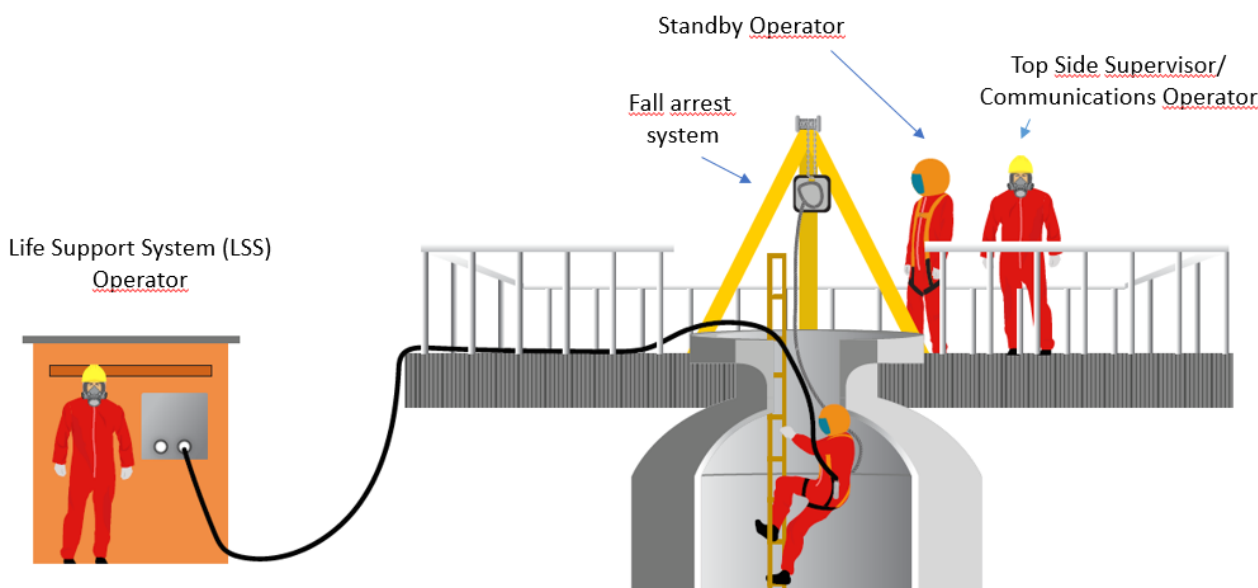

Figure 5: Example of life support system (LSS) organisation for inert entry on the top of a reactor.



Figure 6: Operator with integral helmet and full breathing apparatus. The picture on the right shows the top of a reactor with fall arrest tripod.

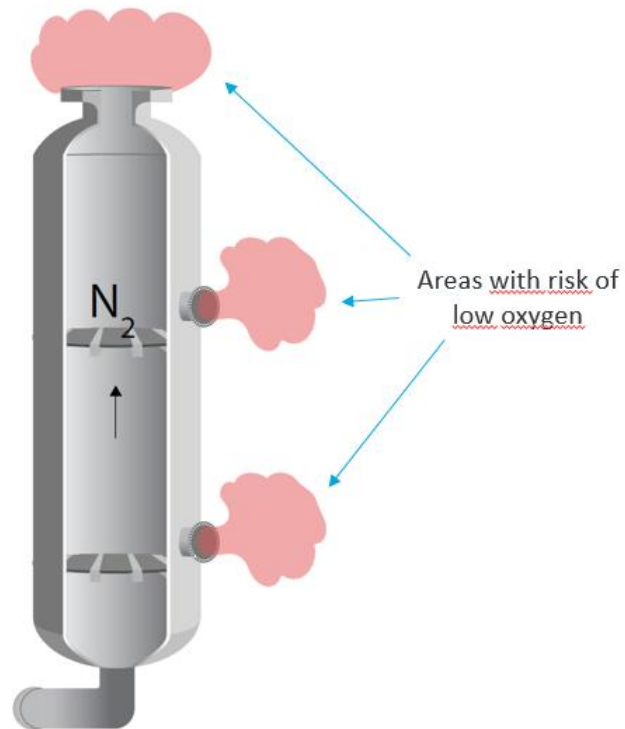

Figure 7: Risks areas during work under inert/nitrogen atmospheres.



Figure 8: Working in catalyst reactor with life support system.

## **7.0 Loading and unloading operations**

This encompasses a wide range of operations including:

### **7.1 Preparation for loading or pre-bagging**

This normally consists of transferring the catalyst from the original packaging into an intermediate hopper.

### **7.2 Loading into or unloading from the reactor**

This is for the new catalyst or emptying the spent catalyst from the reactor.

### **7.3 Screening**

This normally involves removing a top layer or all of the catalyst from a reactor, sieving out undersize material and then the catalyst to the reactor. This may be required due to blocking of the top of the reactor causing pressure drop and flow problems. Sieving is also used to remove other material such as ceramic balls that can be used as an inert support in catalyst beds.

### **7.4 Spent catalyst management**

This includes putting the spent catalyst into suitable packaging for regeneration, recovery or disposal.

### **7.5 Waste management**

This includes managing the empty packaging, used protective suits and other personal protective equipment and collected dust

### **7.6 Ancillary operations**

This includes forklift, crane and temporary scaffolding.

### **7.7 Preparation for loading**

Care needs to be taken to avoid foreign materials such as drum liner, straps and ties from entering the reactor. Prior to loading, the reactor, support grids and ancillary equipment should be inspected. The reactor should be clean and dry.

## 8.0 Loading operations

The key issue is normally how to transfer the catalyst from the packaging for which it arrives on site into reactor. The approach can vary from directly discharging the catalyst from the packaging at ground level and transferring to the top of the reactor to transporting the packaging to the top of the reactor for filling by gravity. The following includes illustrations of the different loading operation. Inside the reactor, the catalyst is normally distributed by either dense loading or sock loading as described in sections 8.4 and 8.5.

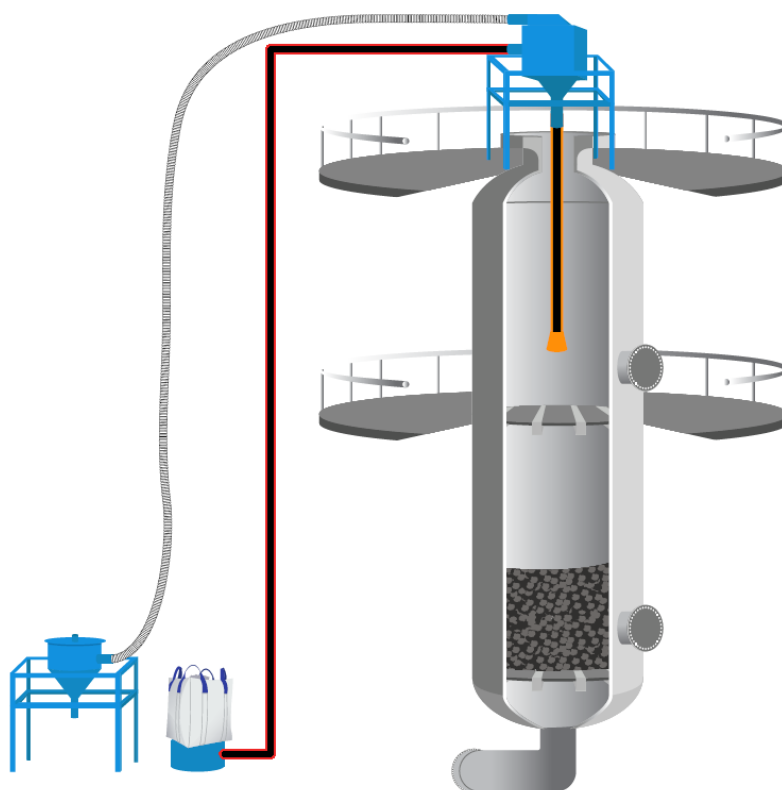

Figure 9: Direct transfer from big bag to reactor. Technology from different catalyst handling companies vary in appearance but work on similar principles.

### 8.1 Vacuum loading

This consists of pneumatically conveying the catalyst directly from UN approved packaging types into the reactor via a hopper. This minimises operator exposure, environmental impact and the requirement for crane support. This is often carried out by a handling company with low attrition equipment approved by the catalyst manufacturer.

### 8.2 Automated systems

These are being actively developed to avoid operators entering reactors. Their use normally depends on reactor design and catalyst type, so cannot be used in all cases. They are normally proprietary technology.



### 8.3 Loading directly from big bags or drums

Where it is not possible to use vacuum or automated systems, the catalyst is transferred directly from big bags or drums as illustrated in below.

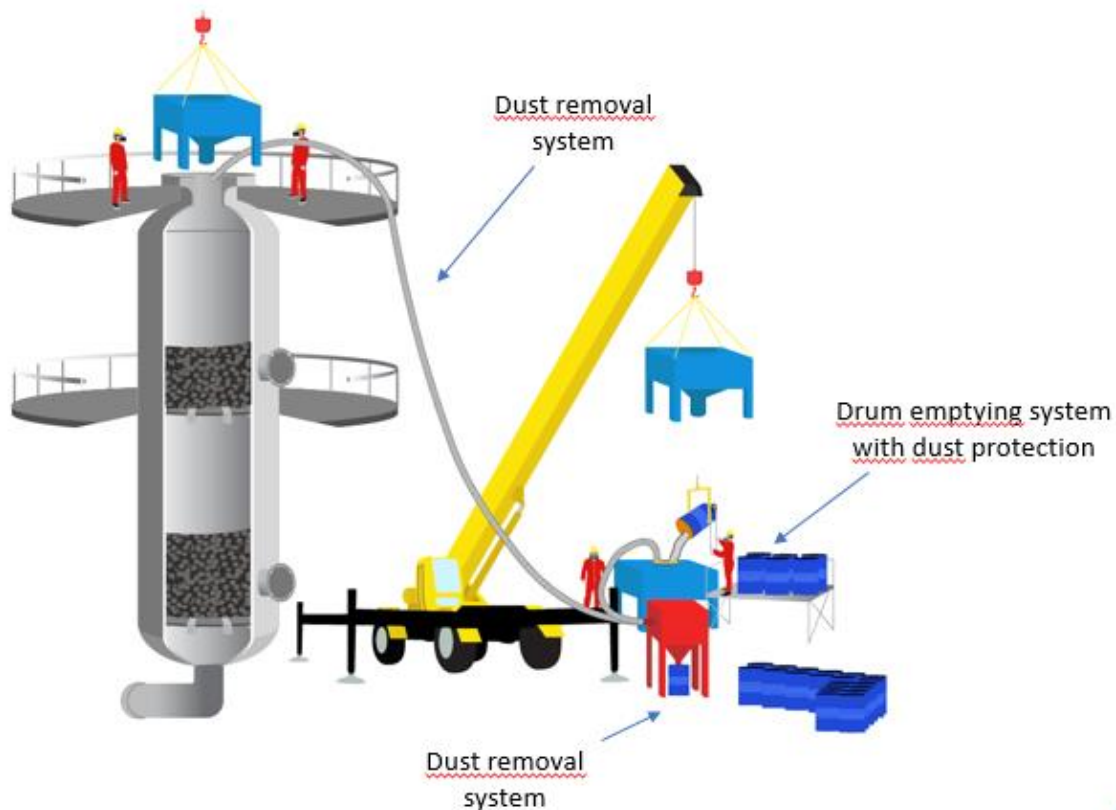

Figure 10: Pre-bagging/filling at ground level where big bag or drum emptying can be better managed and the hopper is lifted by crane.

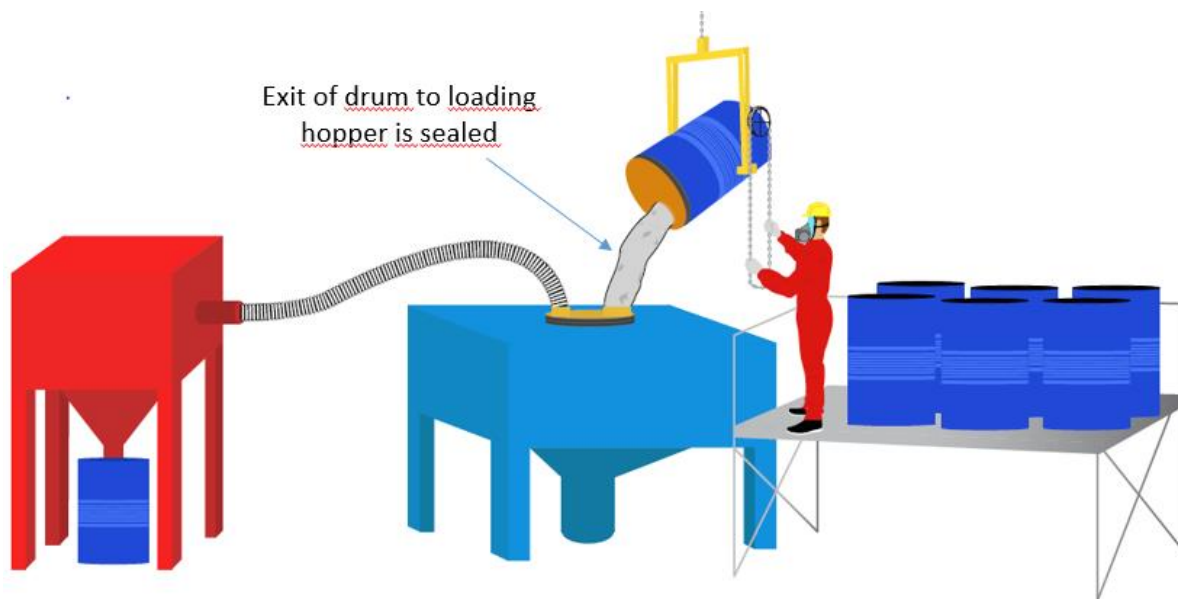

Figure 11: Drum emptying with containment to avoid dust. A lid is placed on the drum that allows the connection to be sealed.

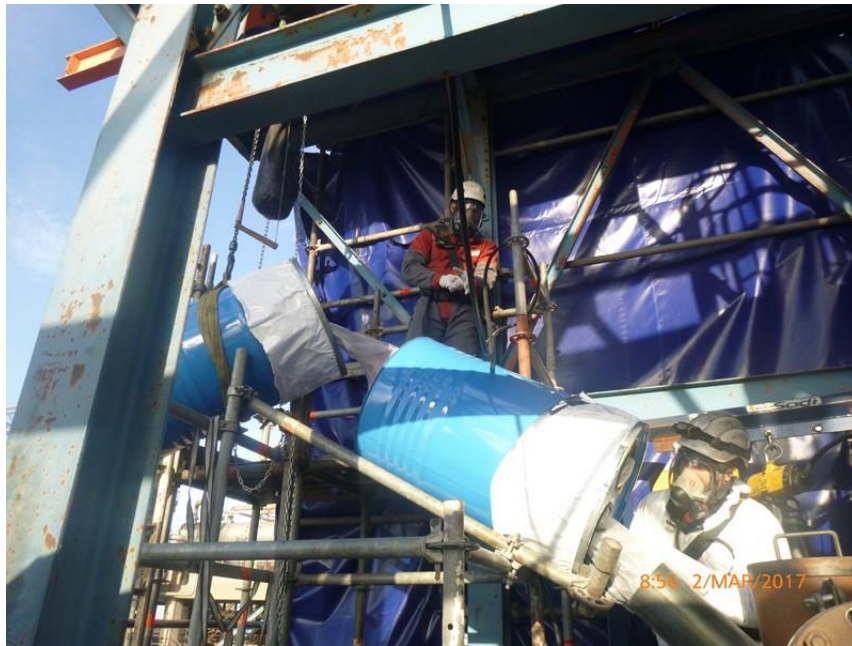

Figure 12: Drum emptying in a difficult location with dust containment. The opening of the drum is enclosed in a sleeve to prevent any dust formation.

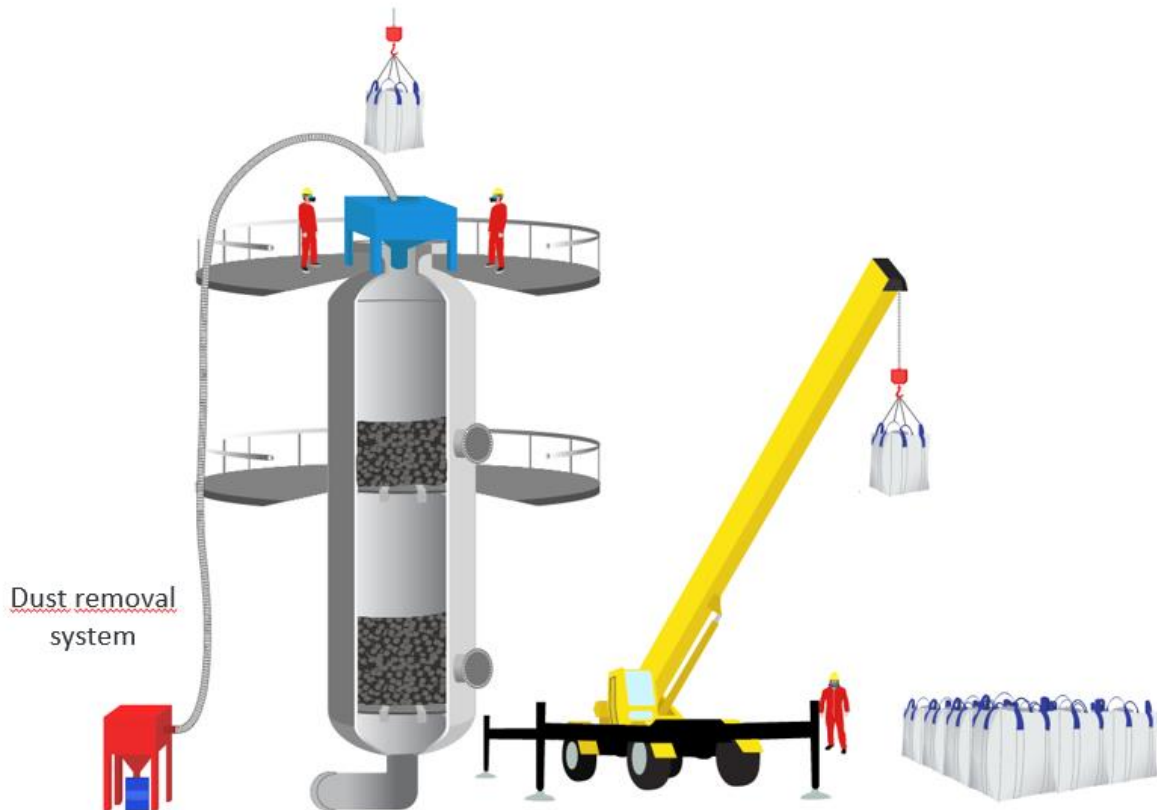

Figure 13: Top mounted loading hopper where big bags are transferred to the top of the reactor and discharged into the loading hopper

## 8.4 Dense loading method

This involves using a device to spread the catalyst more evenly to reduce void spaces and bridging. The device should spread the catalyst over the surface of the catalyst bed while minimising it hitting the side walls. As the catalyst bed is denser, more catalyst can be loaded into the same reactor volume. Dense loading can also reduce channelling where poor or segregated packing allows preferential flow through part of the reactor. A more dense bed will increase the pressure drop over the reactor bed.

The dense loading technologies differ in their methodology, with some using rotating equipment and others relying on air as a propellant to spread the catalyst. Nitrogen can be used in place of air for self-heating catalysts. Dense loading methods require constant operator attention to regulate the feed rate and avoid surges. It normally requires an operator in the reactor to follow loading. Periodic checking of the level and evenness is required during loading.

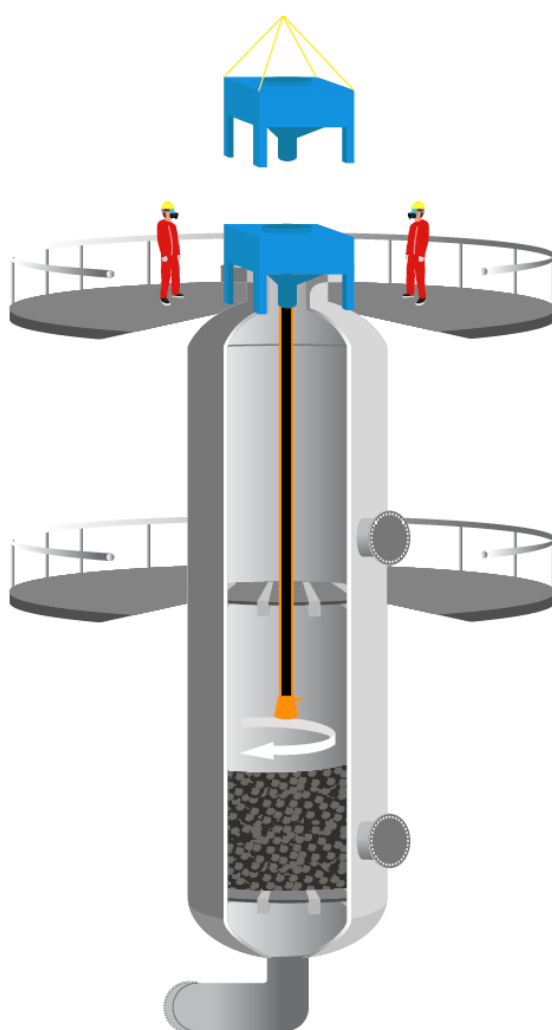

Figure 14: Dense loading method principle.



Figure 15: Dense loading devices.

### 8.5 Sock loading method

This is where catalyst is transferred from a loading hopper at the top of the reactor into the catalyst bed via a flexible sleeve or sock. It typically consists of a rigid pipe attached to the discharge nozzle of the hopper at the top and flexible sock at bottom to keep it full of catalyst. A spreader device at the end of the sock is normally used to evenly spread the catalyst.

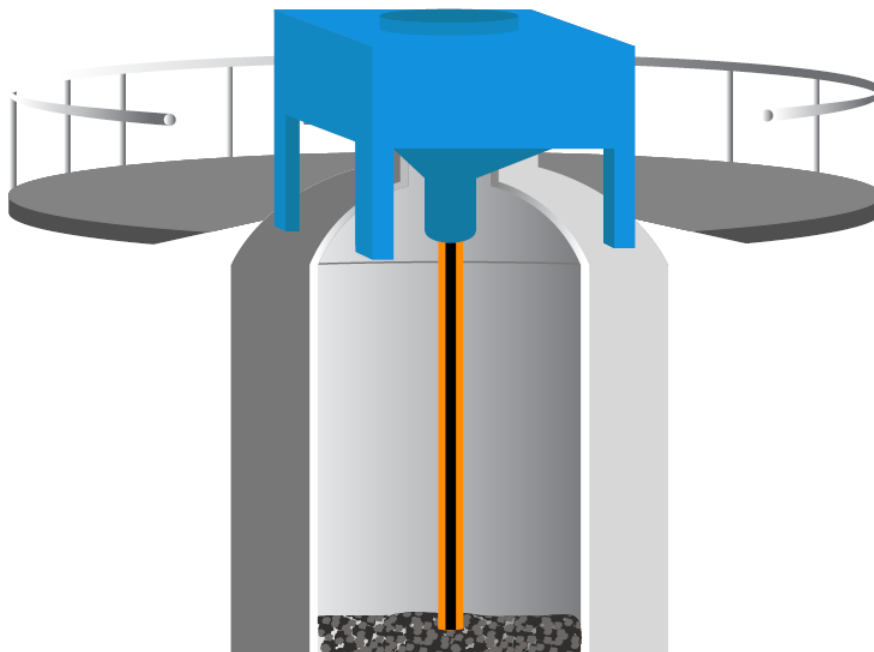

Figure 16: Sock loading principle.

The sock is shortened as operation continues to ensure the drop at bottom of bed is minimised to avoid abrasion and minimise dust formation. The maximum distance between the end of the sock and the top surface of the bed should normally be less than 1 metre. For multiple beds, an operator is normally required

inside reactor to direct the sock. In single beds, it is not normally necessary for an operator to enter the bed, except for levelling. If dense loading is applied, the reactor entry may be avoided.

### 8.6 Tube reactor/reformer loading

This requires directly filling the catalyst into each individual tube and can be a very labour intensive operation.

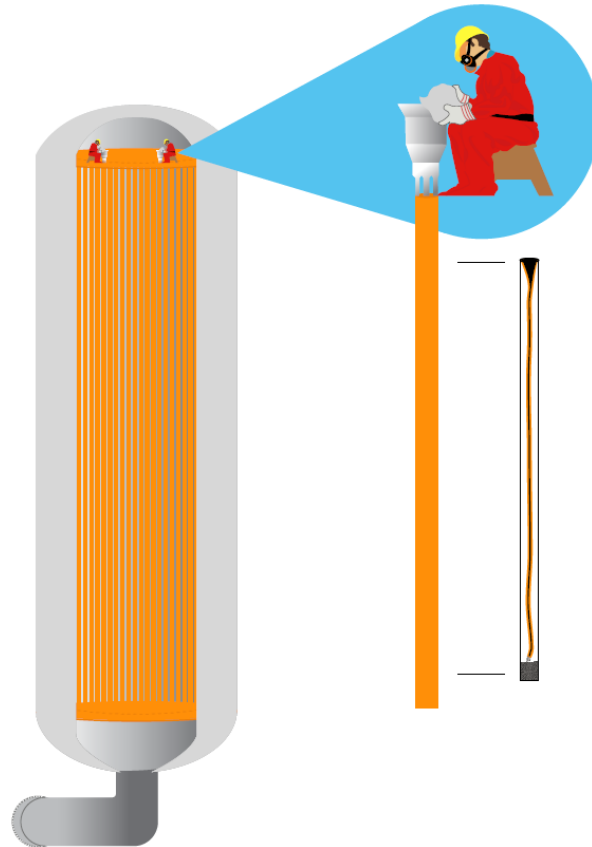

Figure 17: Loading operations for a tubular reactor.



Figure 18: Loading of a tube reactor from the top. The flexible duct is the vacuum system for dust removal.

## 9.0 Catalyst unloading

Before a catalyst can be removed, the reactor must be fully isolated and purged of process fluids. The spent catalyst may also need to be passivated. There are many different reactor designs and the operation has to be adapted to the specific circumstances. Spent catalyst should be loaded into appropriate packaging with regular sampling of spent catalyst. The two main methods are gravity discharging through dump nozzle and vacuuming.

### 9.1 Vacuum unloading

This requires a vacuum to suck the spent catalyst from the reactor. This can minimise exposure to the operator and environment by directly transferring the spent catalyst including dust from the reactor to the packaging such as drums for regeneration, recycling or disposal. As with vacuum loading, this may cause attrition of the catalyst which may be a factor for regeneration. In some cases, entry to the reactor may be required.

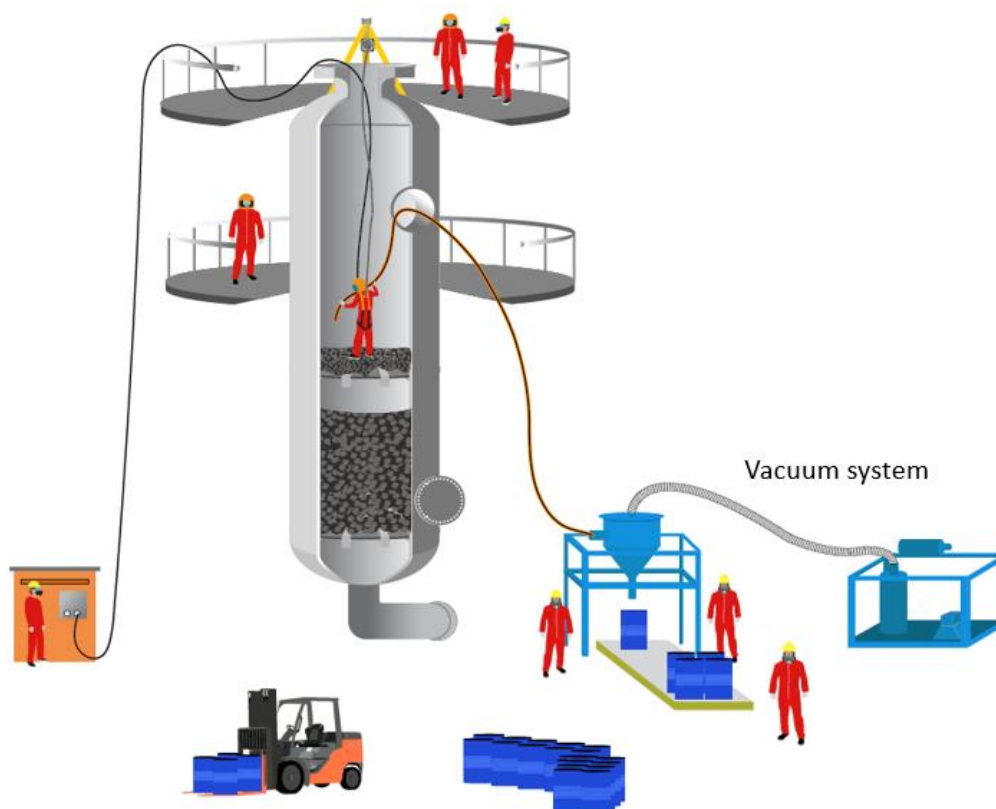

Figure 19: Catalyst unloading under inert atmosphere by vacuum.

### 9.2 Gravity unloading

This requires a nozzle at the bottom of reactor or at the bottom of each bed for multiple bed reactors. Gravity discharging requires constant monitoring to ensure the catalyst is unloading evenly. Not all of the catalyst can be removed this way and the balance must be by vacuuming or shovelling.

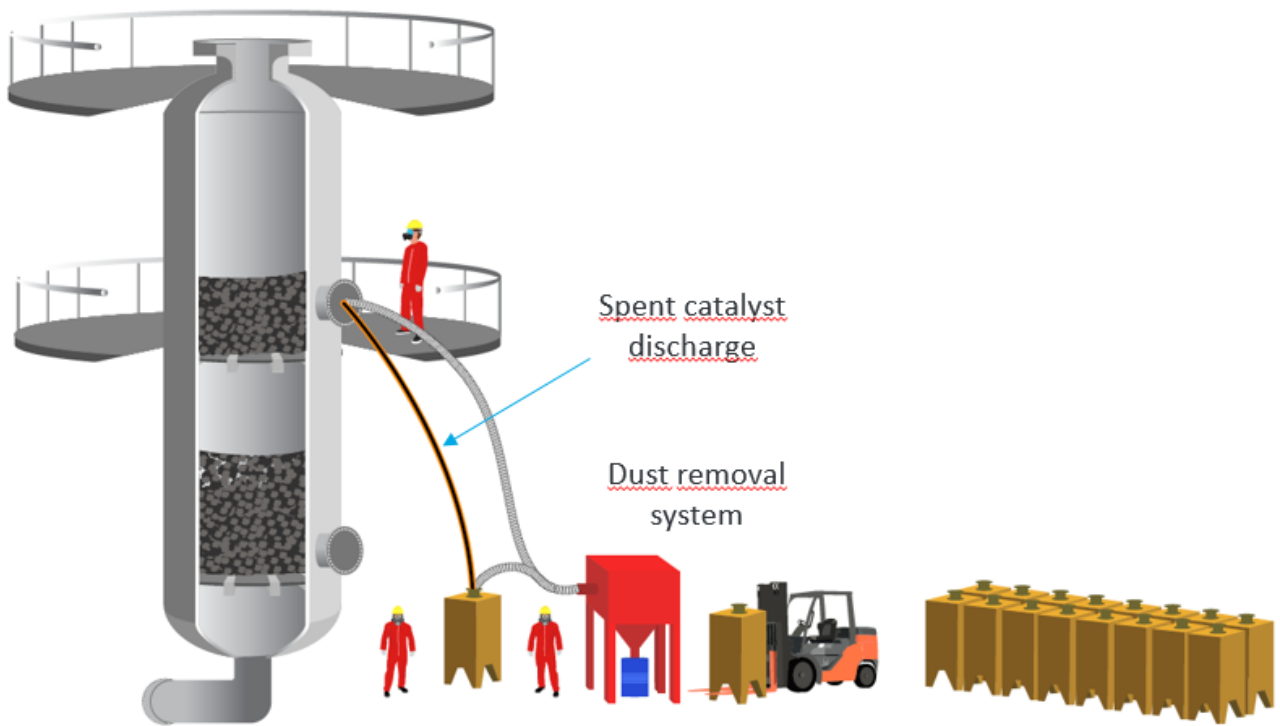

Figure 20: Spent catalyst unloading by gravity into containers.

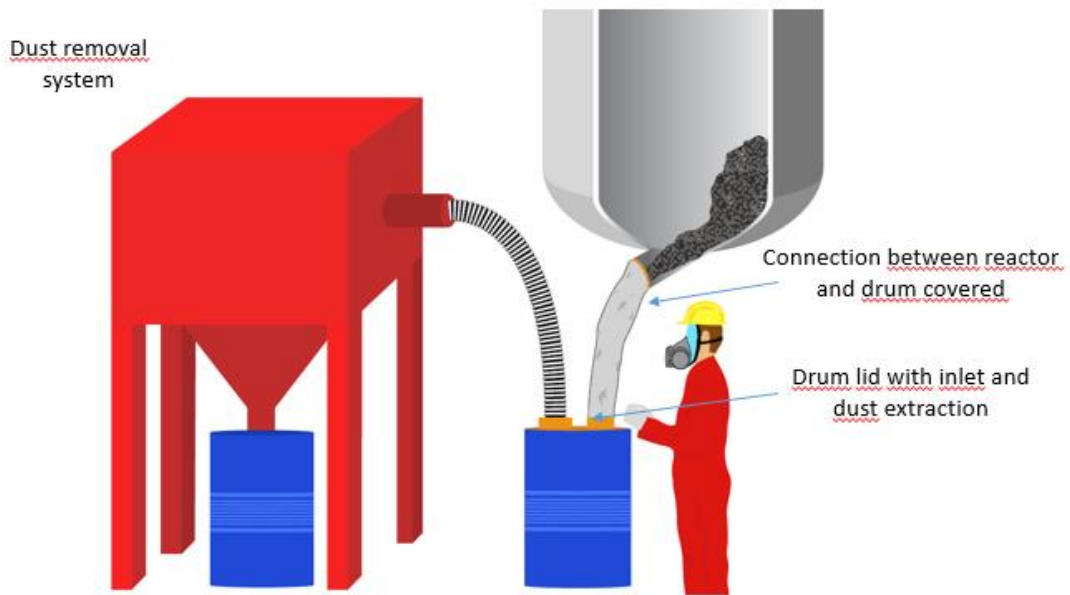

Figure 21: Catalyst unloading by gravity.



### 9.3 Wet unloading

In some cases, spent catalyst can be wetted to minimise dust formation and limit self-heating behaviour. Oil wet unloading is another technique where the catalyst is coated in oil to prevent dust. This depends on the type of catalyst. Care needs to be taken to avoid excess contaminated water.

### 9.4 Agglomerated catalyst

In some cases, the catalyst can be agglomerated in the reactor and techniques are required to break it up to allow emptying. Catalyst agglomeration is normally caused by fouling or moisture. A crust can form on the top of the catalyst bed that can cause a trapped pressure build-up. The pressure drop over the reactor should be tested prior to commencing operations. Specialised techniques may be required to loosen the catalyst.

An operator should not enter a reactor that has a high wall of agglomerated catalyst because this wall could fall and crush the operator on collapse. Typically, the wall height should be less than 1m as shown in Figure 23.

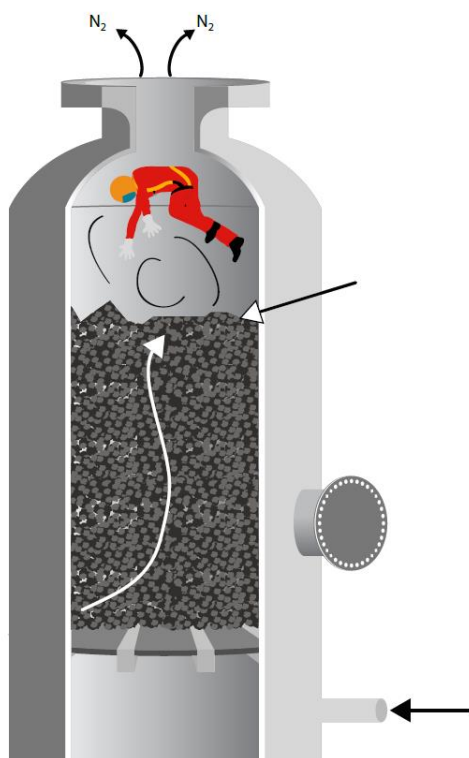

Figure 22: The effect of breaking of the crust on the top of the catalyst bed which had caused pressure build up.

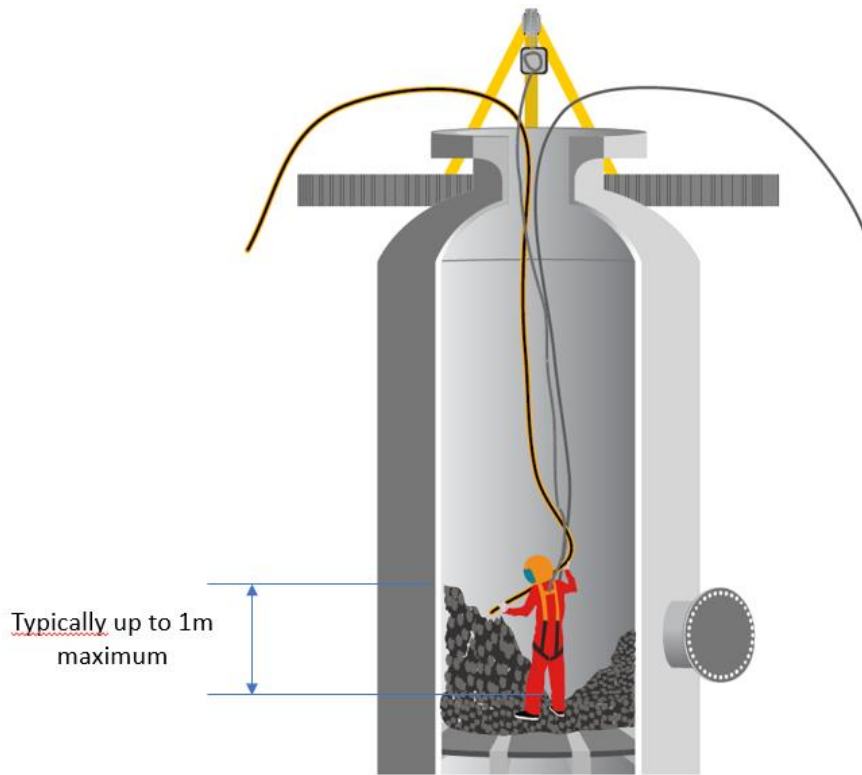

Figure 23: A high wall of catalyst that could crush the operator.

## 10.0 High exposure risks

The areas of highest risk of exposure to catalysts.

Loading	Unloading
Pre-bagging/filling the intermediate lifting hopper from big bags or drums	At the manway or point of entry into the vessel
Transfer of catalyst from lifting hopper or big bag to the loading hopper or vessel	Working within the vessel for unloading the catalyst, cleaning after unloading and internal repairs or modifications
At vessel entrance man way	When exiting the vessel and removing protective clothing
Inside the reactor during loading	Around the dump nozzles and spent catalyst packaging areas
	At the outlet of the vacuum cyclone where spent catalyst is packaged.
	At dust collection and vacuum systems filtration bag house when cleaning
	All equipment cleaning
	Spillages and the cleaning up of spilt catalyst

There may also be a risk of catalyst exposure during maintenance operations such as repairs to pipework and instruments linked to the catalyst reactor.

## 11.0 Personal Protective Equipment (PPE)

It is very important to have comprehensive safety equipment adapted to the specific requirements. A detailed check list is included in the Annex 1 - Best practice list.

The following table is the typical Personal Respiratory Equipment (RPE) employed. This should be reviewed in each case and fit tests are required for all respiratory equipment.

Situation	Location	Respirator
Inert atmosphere such as nitrogen	Inside reactor	Integral helmet and appropriate air supply
	Top side near open manway (around 1.5m)	
	Near dump nozzle (around 1.5m)	
	Top side away from open point of reactor	Full or half face P3 with fit test
Other cases subject to risk assessment	Inside reactor	Other breathing apparatus or respirator
	Top side near open manway (around 1.5m)	
	Near dump nozzle (around 1.5m)	
	Top side away from open point of reactor	Full or half face P3 with fit test
Screening/sieving Operator	High risk cases	Integral helmet and appropriate air supply
	Other cases subject to risk assessment	Full or half face P3 with fit test
Pre-bagging Operator		Full or half face P3 with fit test
Ancillary Operator		Full or half face P3 with fit test

The United Kingdom Health and Safety Executive (HSE), Respiratory protective equipment at work, HSG53, a practical guide, is a useful document on the use of RPE.

## Personal protective equipment should comply with applicable standards

Safety equipment	Applicable standards
Overall PPE regulation	Regulation (EU) 2016/425 on Personal Protective Equipment (PPE)* CE Approved equipment should be used.
Full breathing apparatus	EN 14593-1: 2018 Respiratory protective devices. Compressed air line breathing devices with demand valve. Devices with a full face mask. Requirements, testing and marking United Kingdom Standard Assigned Protection Factor 2000 (APF 2000) or equivalent. EN 136:1998 Respiratory protective devices. Full face masks. Requirements, testing, marking EN 402:2003 Respiratory protective devices. Lung governed demand self-contained open-circuit compressed air breathing apparatus with full face mask or mouthpiece assembly for escape. Requirements, testing, marking
Respirators/Filters	EN 136:1998 Respiratory protective devices. Full face masks. Requirements, testing, marking EN 140: 1999 Respiratory protective devices. Half masks and quarter masks. Requirements, testing, marking EN 143:2000 Respiratory protective devices. Particle filters. Requirements, testing, marking EN 12941:1998+A2:2008 Respiratory protective devices. Powered filtering devices incorporating a helmet or a hood. Requirements, testing, marking EN 12942:1998+A2:2008 Respiratory protective devices. Power assisted filtering devices incorporating full face masks, half masks or quarter masks. Requirements, testing, marking
Protective suits	EN ISO 13982-1:2004+A1:2010 Protective clothing for use against solid particulates. Performance requirements for chemical protective clothing providing protection to the full body against airborne solid particulates (type 5 clothing) (example Tyvek) or equivalent
Eye wear	EN 166:2002 Personal eye protection. Specifications
Head	EN 397:2012+A1:2012 Industrial safety helmets
Footwear	EN ISO 20346:2014 Personal protective equipment. Protective footwear
Gloves	EN 388:2016 Protective gloves against mechanical risks EN ISO 374-1:2016 Protective gloves against dangerous chemicals and micro-organisms. Terminology and performance requirements for chemical risks
	Other EN standards maybe applicable.

\* There is a transition period of 1 year from 28 April 2018 to 20 April 2019, where both the old Directive and the new Regulation are applicable. Therefore PPE designed and manufactured in accordance with Directive 89/686/EEC can still be placed on the market until 21 April 2019.

## Annex 1 - Best practices list

The following is a list of items that should be considered in catalyst handling operations.

### REACTOR AND SITE DESIGN

Reactor design	
Installation and removal of the catalyst is taken into consideration in the design of the reactors	
Ensure catalyst can be loaded easily to maximise process performance	
Bottom dumping nozzles to allow spent catalyst to be unloaded by gravity	
Side discharge nozzles and access manways for multi-bed units	
Suitable height and space under the reactor for bottom discharge if applicable	
Will operators need to enter reactor during loading and unloading	
Electrostatic discharge	
Site design	
Catalyst reactors have good access platforms and stairways with space for operators and equipment	
Clear space around the top of the reactor for movement by equipment such as cranes	
Well located structures, piping and electrical cables	
Access around reactor base for equipment such as cranes, forklifts and temporary catalyst storage	
Allow for the working area to be cordoned off during loading and unloading operations with minimum disruption to other operations	
Clear surfaces to allow any spillage to be easily cleaned up	
Drain design to allow easy covering in case of spill	

### PREPARATORY ORGANISATION

Pre-visit – items to cover	
Ensure a pre-visit takes place	
Catalyst type including Safety Data Sheet (SDS)	
Expected condition of spent catalyst	
Reactor design	
Process requirements such as isolation of the reactor including utilities	
Catalyst installation and removal method	
Access for operators and equipment	
Inert atmosphere/confined space entry requirements	
Review of history and experience of previous operations	

<b>Method statement</b>	
Prepared prior to interventions	
Standard procedures adapted to specific site requirements	
Permit system in place for all reactor entry	
<b>Risk assessment</b>	
The task	
Work environment	
Working materials and tools	
Suitability of those carrying out the task	
Inert atmosphere/Confined space entry	
Catalyst Safety Data Sheet (SDS)	
Evaluation of the potential condition and hazard of spent catalyst	
Environmental risk	
A safety meeting including site safety representative before commencement of the work	
<b>Work in confined space/inert atmosphere</b>	
Detailed procedures for use of inert/nitrogen	
Open manholes, weather protection and under vessels are treated as inert atmosphere	
Open manholes have barriers with warning labels	
<b>Rescue plan</b>	
Location of trained responders on site	
Location of trained responders off site	
Rescue equipment available	
Vessel evacuation procedure	
Compatibility of on-site rescue equipment with catalyst handling equipment	
On-site rescue personnel have at least the same level of PPE protection as those they are rescuing	
On-site rescue personnel with breathing apparatus have at least the same level of air duration as those they are rescuing	
Accessibility of the location	
Use of retrieval systems	
<b>Work organisation</b>	
Work undertaken by suitably qualified technicians	
Clearly define Supervisor for the operation	
Clearly define responsible site representative/supervisor	
A clear hand over and records of process checks and isolation before handover	

Automated system possible to avoid operator entry	
<b>Record keeping</b>	
All key steps and interventions should be recorded	

## PROCESS AND PACKAGING

<b>Process</b>	
Check process safe before commencing operations	
Pressure drops checks to ensure no crust build up	
Sampling programme for spent catalyst	
Spent-heating catalyst filled into drums/bins under a nitrogen blanket	
<b>Packaging</b>	
Includes big bags (FIBC), drums and forklift movable 1 – 2m <sup>3</sup> bins	
Designed to minimise the changeover of bags and drums to reduce exposure	
Dust extraction with bag filtration used during emptying	
Receiving hopper designed with a cover to minimise dust	
Big bags with a double outlet sleeve (the outer sleeve is designed to be clamped during emptying help to prevent dust)	
Drum emptying with suitable equipment to minimise dust including extraction	
Screening device to prevent foreign matter entering the reactor	
Verify if packaging can be directly re-used for spent catalyst and other waste	
Packaging is certified	
All 4 corners of the empty big bag are shaken vigorously to remove remaining material (This is the main location for residues)	
The empty big bag is folded carefully immediately after discharge and placed into a polyethylene bag and sealed (Empty unfolded big bags discarded for later sorting and folding should be avoided)	

## DUST AND ENVIRONMENT

<b>Dust minimisation</b>	
Dust source can be removed	
Number of transfer operations minimised	
Pre-bagging equipment has containment/covers	
Dust removal equipment at pre-bagging area (loading)	
Dust removal equipment at reactor loading point (loading)	
Dust removal equipment at other reactor openings	
Dust removal equipment at reactor discharge point (unloading)	
Dust removal equipment for receiving vessel such as drum (unloading)	



Dust removal equipment maintenance and cleaning programme	
Direct loading of the collected dust into receiving vessel such as drum	
Wind protection screening to prevent fugitive emissions	
<b>Settled dust and spill management</b>	
Cover sheets for difficult surfaces such as gratings and equipment	
Drains covers	
Spills cleaned immediately to avoid dispersion by shoes, vehicles and wind	
Spill cleaned by vacuuming to avoid dust and minimise residues. No sweeping.	
Disposed in an appropriate way	
<b>Waste management (see Catalysts Europe - Guidelines for the management of spent catalysts)</b>	
Spent catalyst in appropriate containers such as drums or bins	
Used packaging collected and disposed of	
Used personnel protective equipment collected and disposed of	
Handling equipment and working area cleaned by vacuum prior to demobilisation and handover	

## OPERATOR HYGIENE

Operator hygiene facility located near operations	
Residual dust vacuumed before removal of coverall	
No eating or drinking in the loading area	
Facility for dust removal	
Containers for used personnel protective equipment	
Dirty changing area	
Wash area	
Clean changing area	

## SAFETY SYSTEMS AND EQUIPMENT

<b>Safety systems</b>	
Documented safety system	
Third party approved safety system such as ISO or other country specific standards such as VCA in the Netherlands	
Contractor safety system, if applicable	
ISO45001 (previously OHSAS 18001) certification	
Regular audits and checks are carried out	
Training reactors used for initial and refresher training	
Initial training programme	

Refresher training programme	
<b>Personal Protective Equipment (PPE)</b>	
Eye and face protection	
Hand protection (Gloves to suit the specific requirements)	
Hearing protection	
Safety shoes	
Head protection	
Coverall	
Coverall – Anti-static flame resistant fabric when risk	
Coverall - Chemical resistant disposable coverall when required	
Respiratory equipment suitable for the requirements	
Fit test to check that the required equipment fits properly on each individual	
PPE such as coveralls replaced when torn or damaged	

## TRAINING AND QUALIFICATIONS

<b>Training requirements</b>	
Documented training requirements	
Documented competency assessments	
Minimum training and experience periods	
<b>Supervisor/Operator training requirements</b>	
Basics of breathing and toxicology training	
Safety Data Sheets (SDS)	
Threshold limit values and explosion risks	
Regulatory requirements	
Catalyst handling training	
Identification and risks of confined spaces	
Measurement of toxic and harmful gases and vapours and explosion risks	
Making confined spaces with explosion risks inert	
Training on all equipment and its use	
Safe work methods	
Practice in training reactors	
Emergency procedures and rescue operations	
Refresher Training	

<b>Ancillary operator training requirements</b>	
Basic training and awareness of listed areas	

## **INERT ENTRY, IF APPLICABLE**

<b>Inert entry equipment</b>	
Anti-panic lockable integral helmet with breathing apparatus	
Minimum of 3 independent air sources	
Self-contained cylinder (escape set)	
Apparatus operates under positive pressure	
Integral communication system between Standby Operator, Communications Operator and Life Support Operator	
Constant monitoring of O <sub>2</sub>	
Constant monitoring of H <sub>2</sub> S (if assessed as required)	
Constant monitoring of CO (if assessed as required)	
Constant monitoring of Lower Explosion Limit (LEL) if shown to be a risk	
Constant monitoring with radio	
Recording system with radio	
Constant monitoring with camera particularly if no direct sight	
Recording system with camera particularly if no direct sight	
Equipment is explosive proof where the risk is identified	
Fit test to check that the required equipment fits properly on each individual	
Full body harness	
Body harness certification	
Retractable fall arresters	
Permanent anchor point for retrieval system	
Certified anchor point	
Good arrangement for A frame temporary anchor point	
Intrinsically safe lighting	
Cover with lock for the manhole to prevent unauthorised access	
Warning signs	
Rescue stretcher or rescue triangle or similar	
Daily inspection with maintenance and testing after each project	

<b>Life Support System (LSS)/Standby Operator responsibilities</b>	
Strictly control entry into inert atmosphere	
Immediately control the withdrawal of personnel when exposure to hazards being monitored or tested goes above or below safe levels	
Remain at his post at all times when personnel are operating in inert atmosphere	
Maintain constant communications with personnel in the inert atmosphere	
Have an established means of raising the emergency rescue team or site rescue service	
Have a thorough understanding of the rescue plan and his/her involvement	
Ensure that the means of entry into inert atmosphere is signed and any access is restricted during periods when personnel are away from the confined space	
<b>Top Side Supervisor or Communications Operator responsibilities</b>	
Record all entries and exits made on the entry log and ensure that personnel are wearing the appropriate safety equipment for entry	
Have a thorough understanding of the rescue plan and his/her involvement	
Hand over the log to oncoming Communications Operator (works continuing) or to his supervisor at the end of the operation	
Remain at his post at all times when personnel are operating in inert atmosphere	
<b>Life Support Operator responsibilities</b>	
Remain in the vicinity of the Life Support Unit at all times when personnel are operating in inert atmosphere	
Ensure that the air supply is guaranteed	
Have a thorough understanding of the rescue plan and his involvement.	

## **MONITORING**

<b>Medical monitoring</b>	
Regular medical examination	
Eye Exam	
Blood Pressure (BP)	
Audiogram (dB Hearing Test)	
Electro-Cardio Gram (ECG)	
Pulmonary Function Test (PFT)	
Physical Examination	
Stress Test (Stamina and Recovery)	
Qualitative Urine Sample (Sugar & Glucose)	
Quantitative Blood Sample (Liver and Blood Count)	

<b>Bio-monitoring</b>	
Regular bloods and urine tests for catalyst substances as required	
<b>Exposure monitoring</b>	
Regular Occupational Exposure Monitoring of personnel involved in operations	
Tests that Operators are safely working below the Occupation Exposure Limit (OEL) for substances being handled based on the information in the Safety Data Sheet and process substances that may be present such as benzene	